

# Paw The Poodle Tales

A Day at the Amusement Park

Coloring & Activity Book



Created by

*Toni Tusó Faber*

*Illustrated by J.D. Gross & Michelle Mata*

# The Poodle Tales

*A Day at the Amusement Park*

Coloring & Activity Book

This book belongs to:

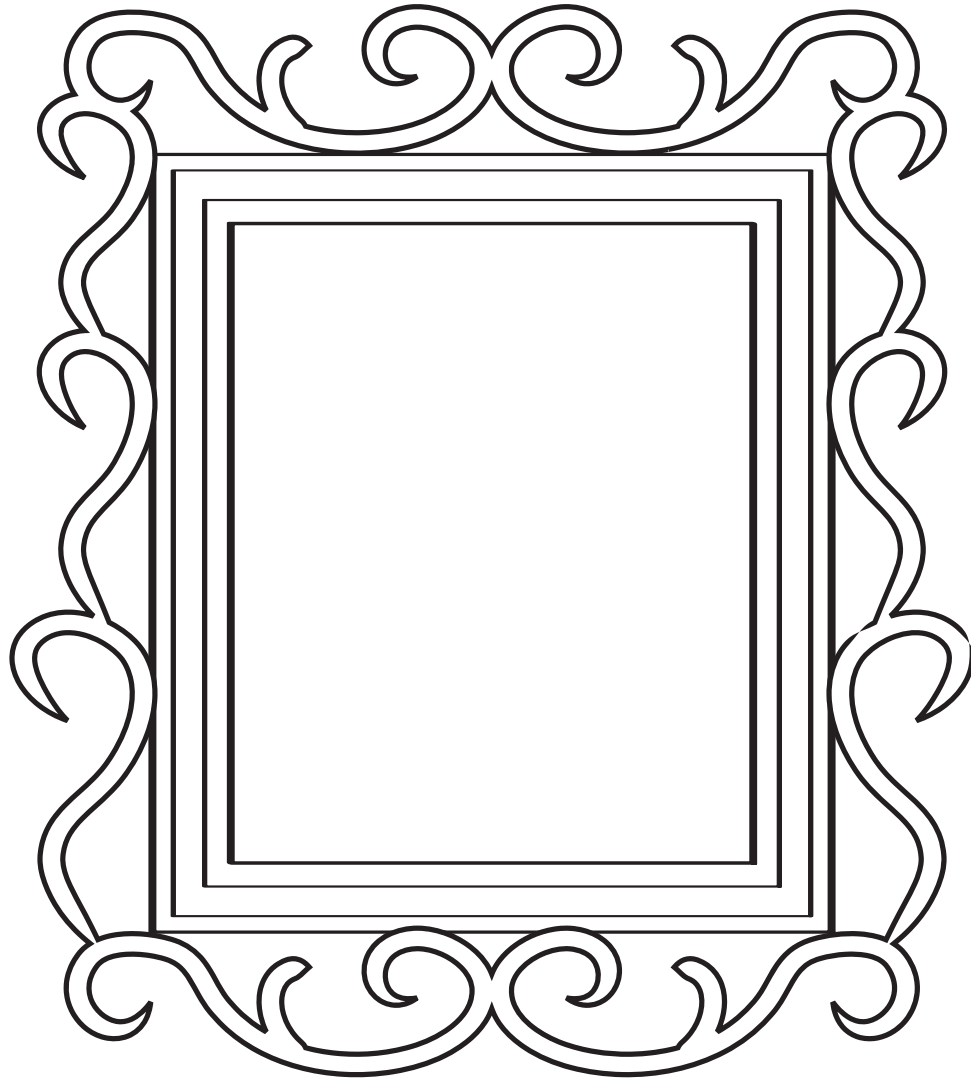

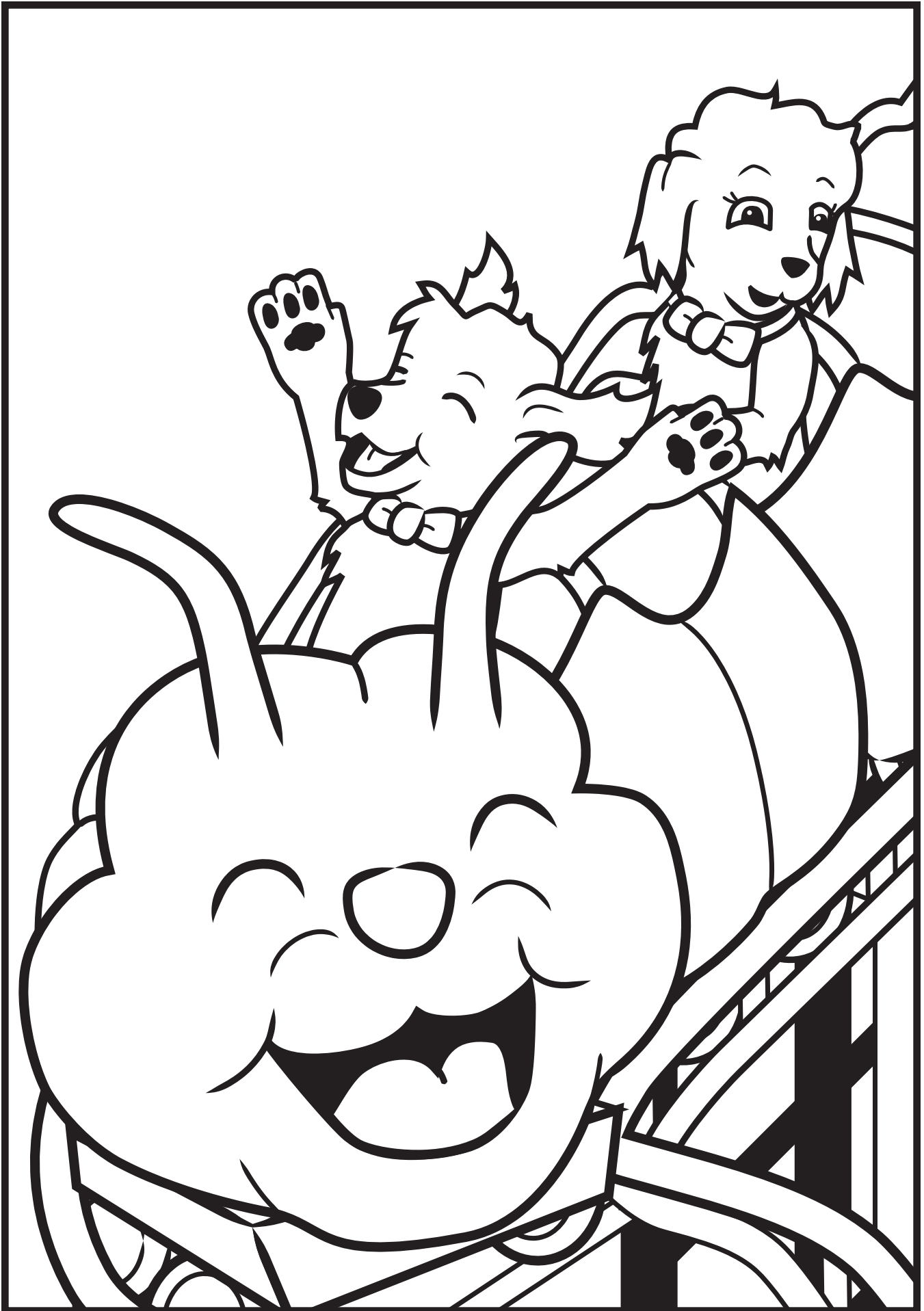

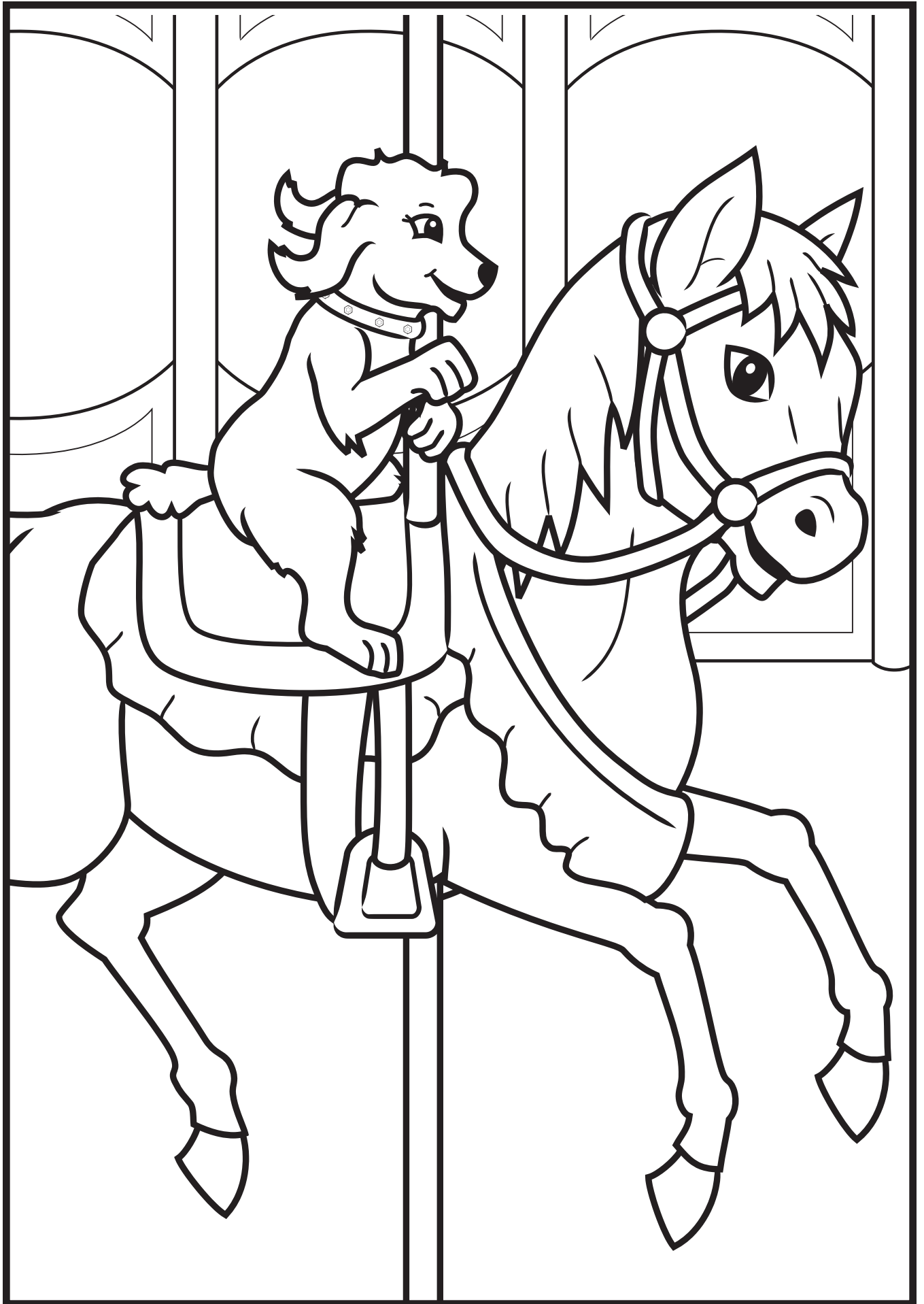



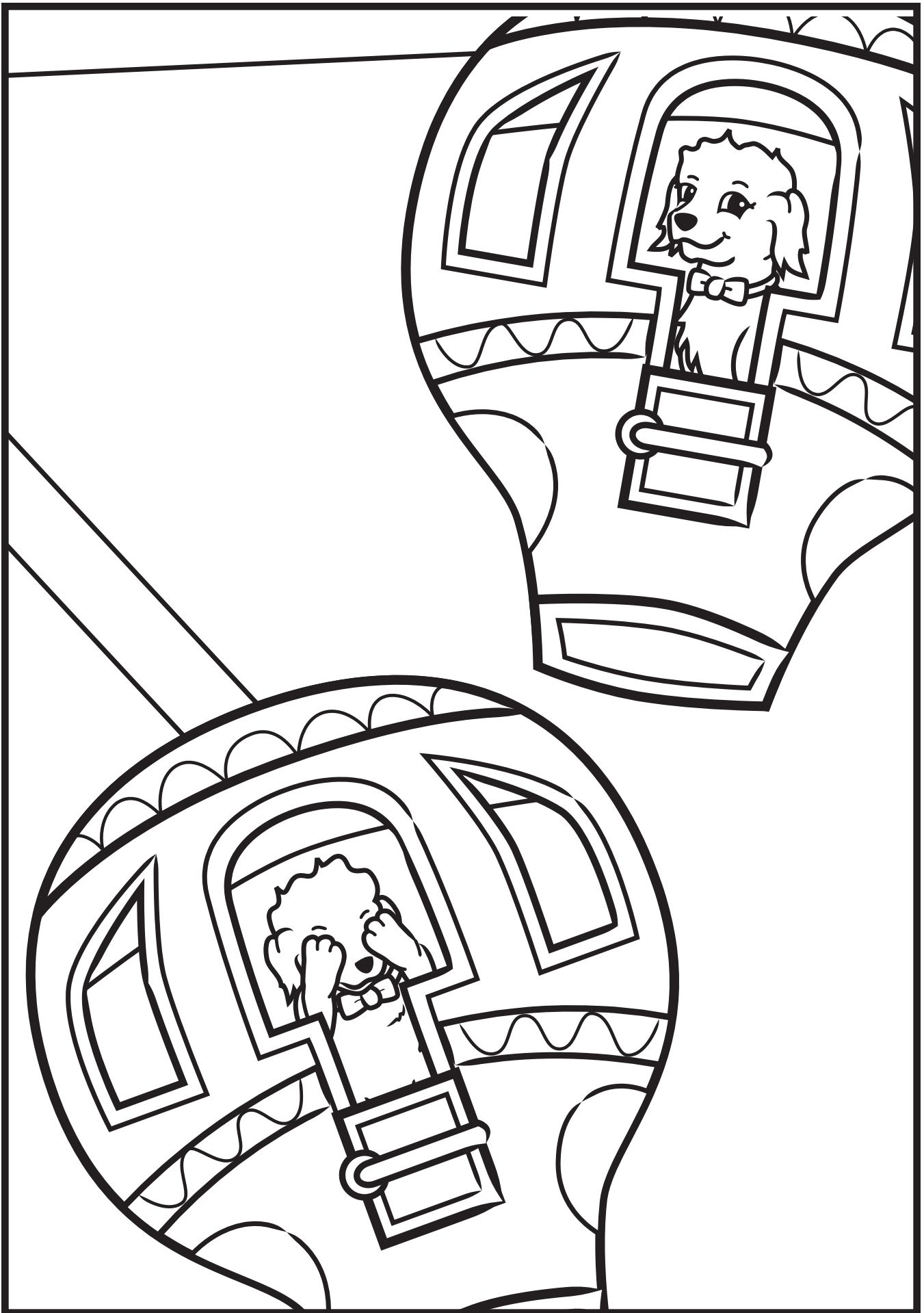

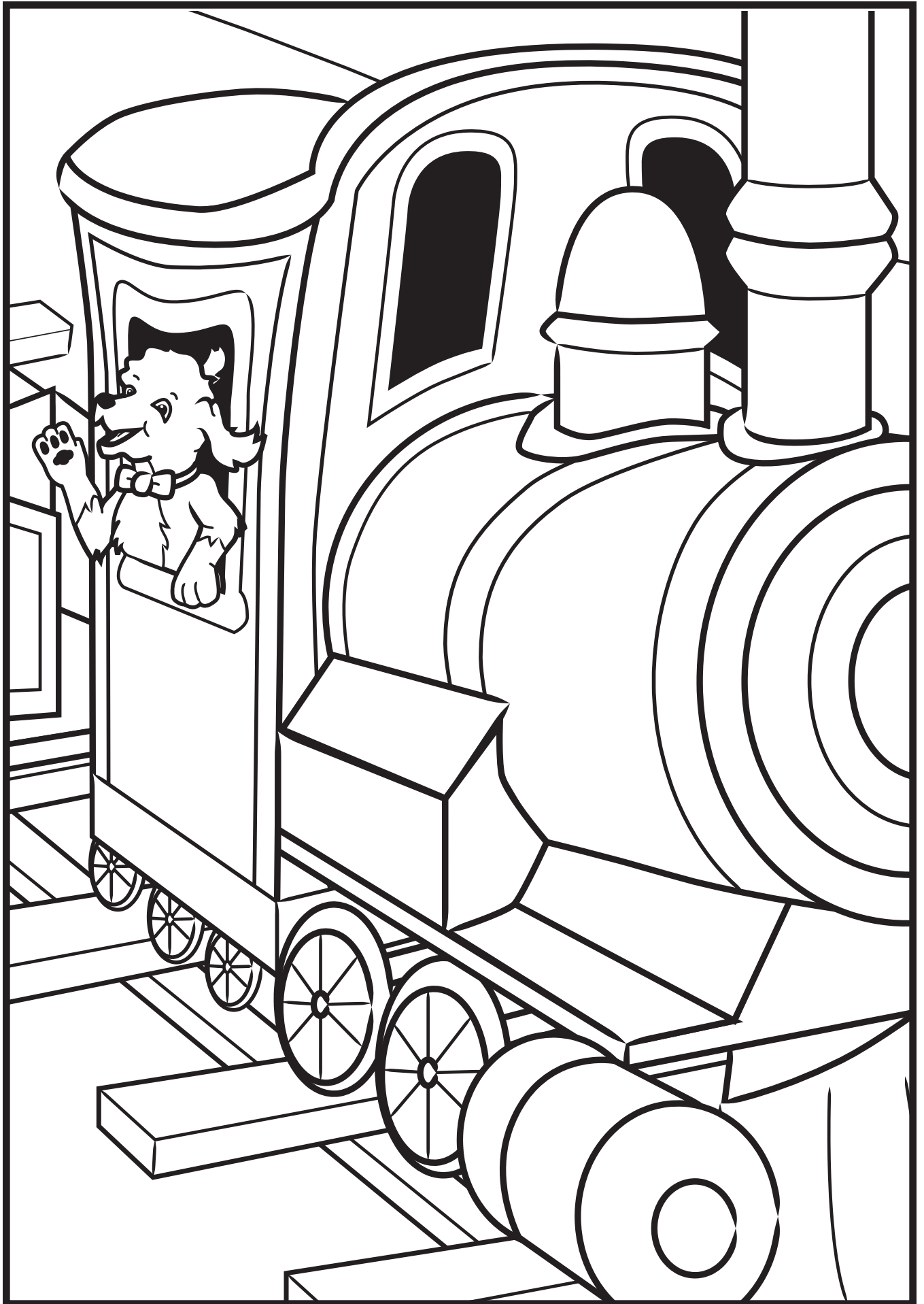

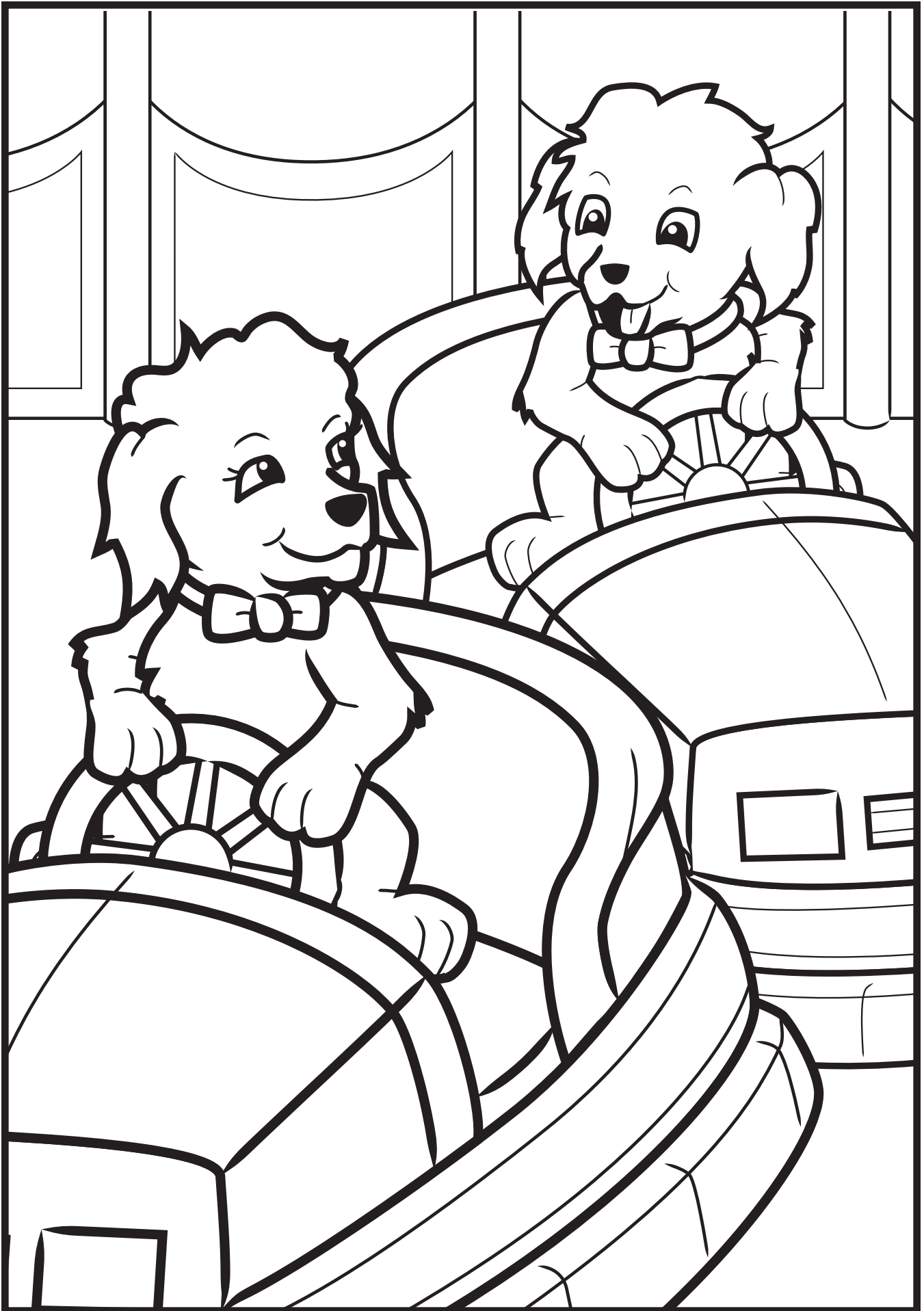

**COTTON CANDY ICE CREAM**



# What would a poodle use?

Circle the things a poodle is likely to use.



Answer: 1, 2, 3, 6, 9, 11, 14, 15, 16  
 Also 8, 10, 13, 18 if you're a Poodle Tales poodle!



# What would you find at an amusement park?

Circle the things you are likely to find at an amusement park.

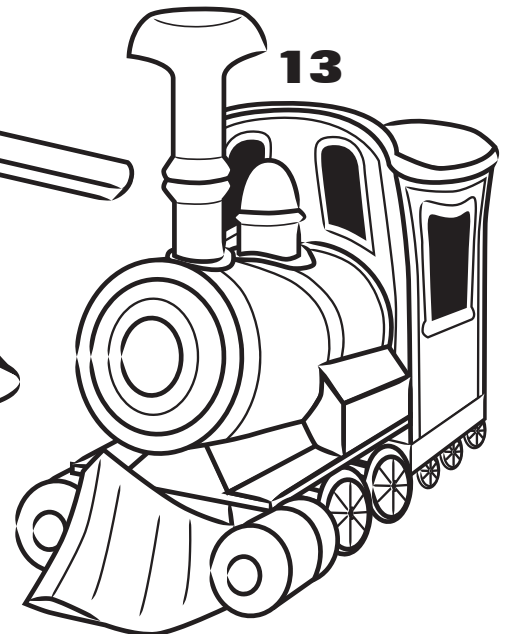
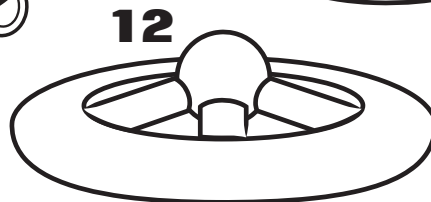
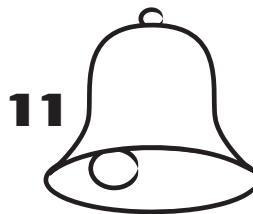
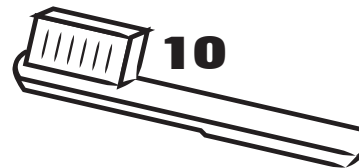
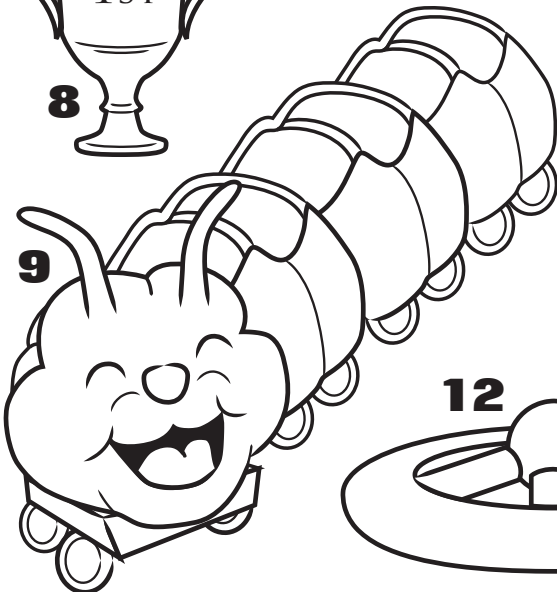
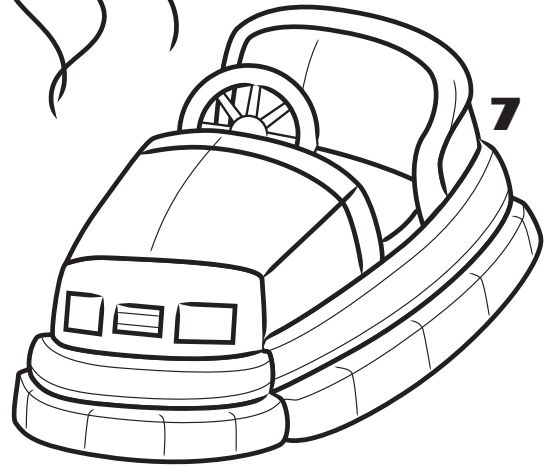
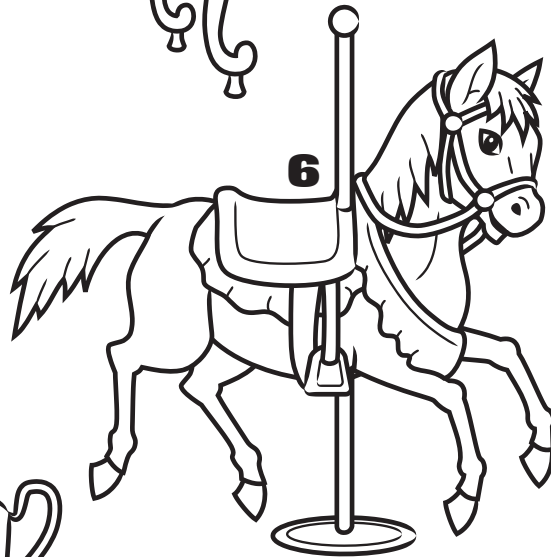
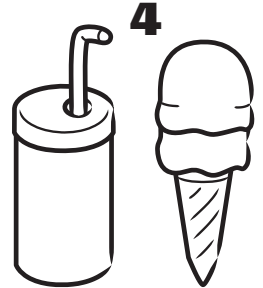
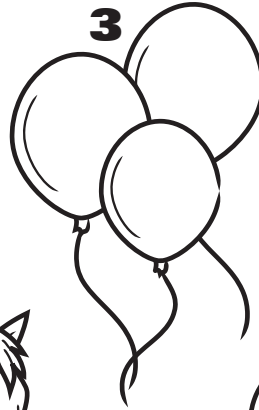
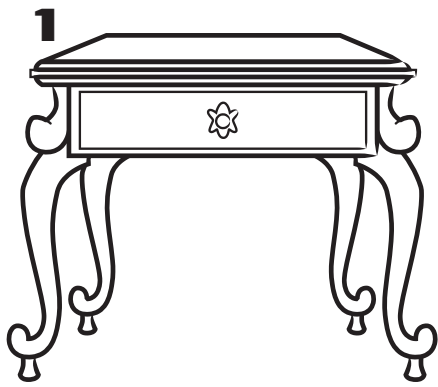

Answer: 2, 3, 4, 6, 7, 9, 13

# Matching Game

Draw a line from the carousel horse in the left column to the carousel horse in the right column that looks exactly the same.

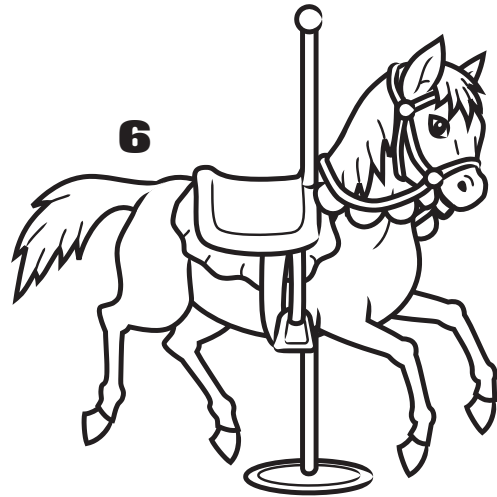
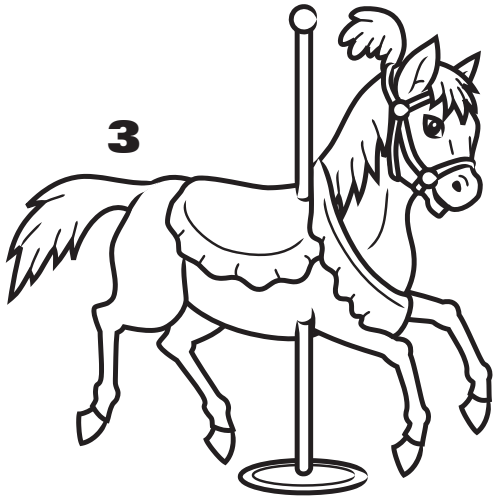
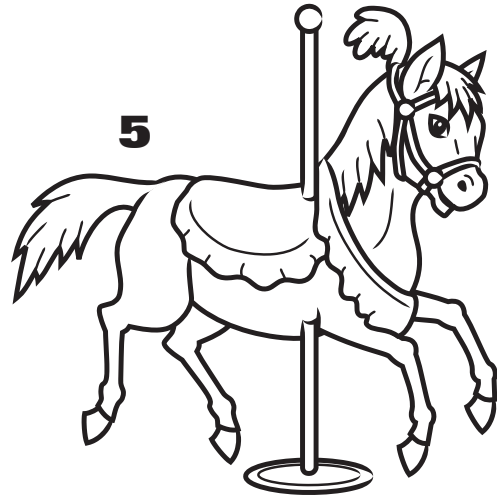
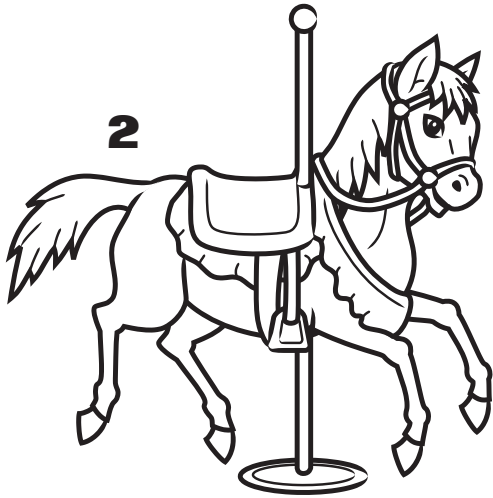
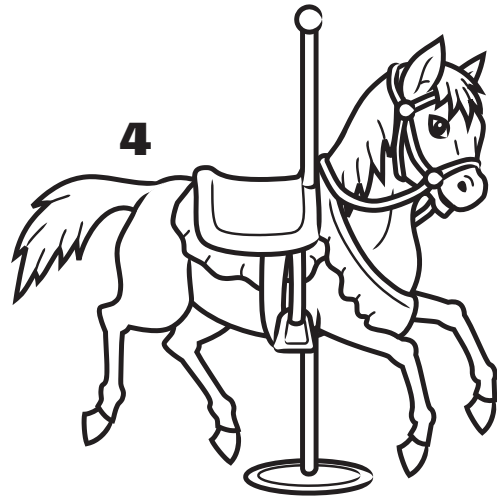
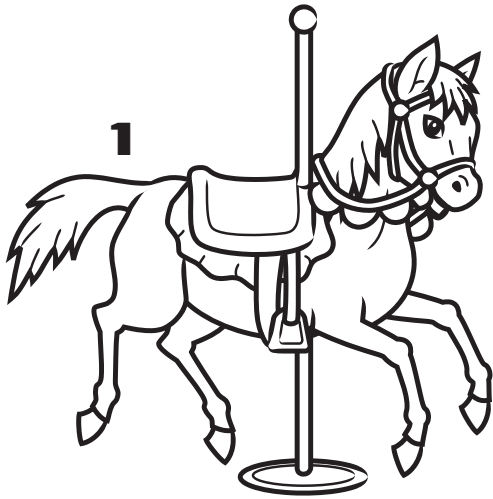

Answer: 1-6, 2-4, 3-5

# Which picture is different?

Circle the raft that does not match the others.

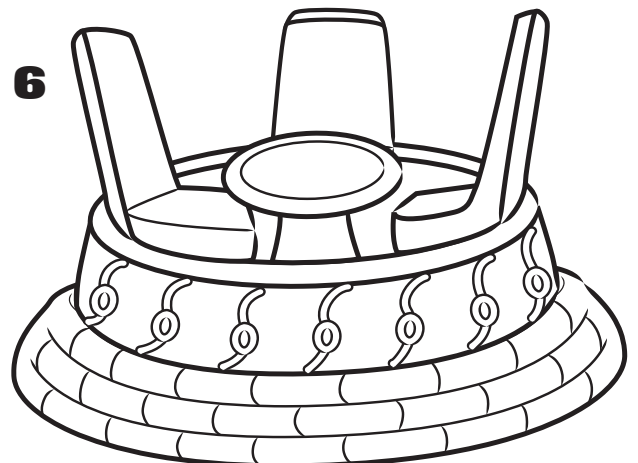
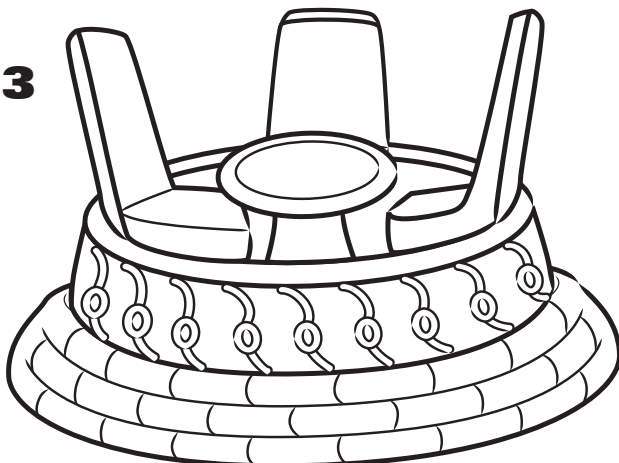
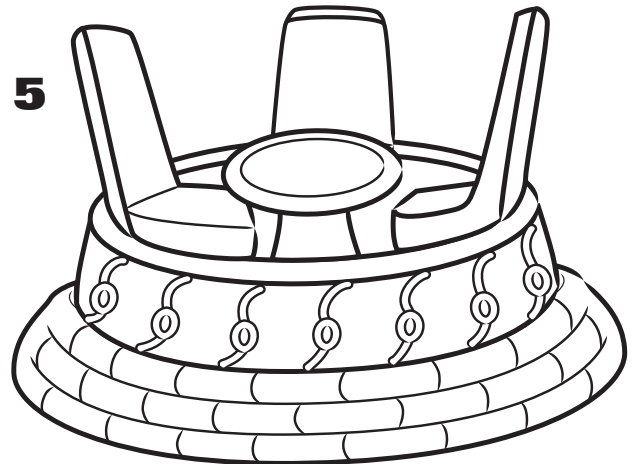
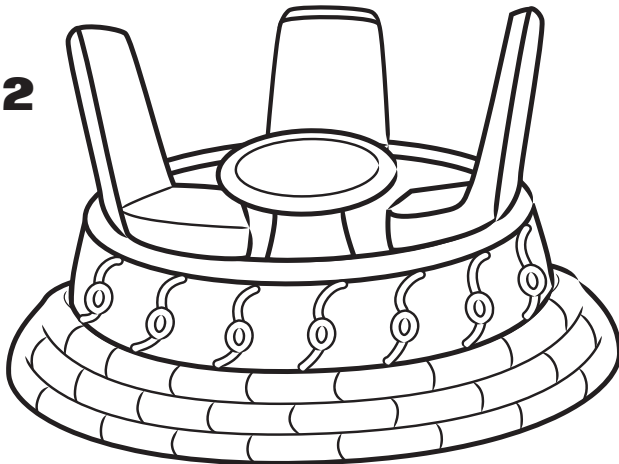
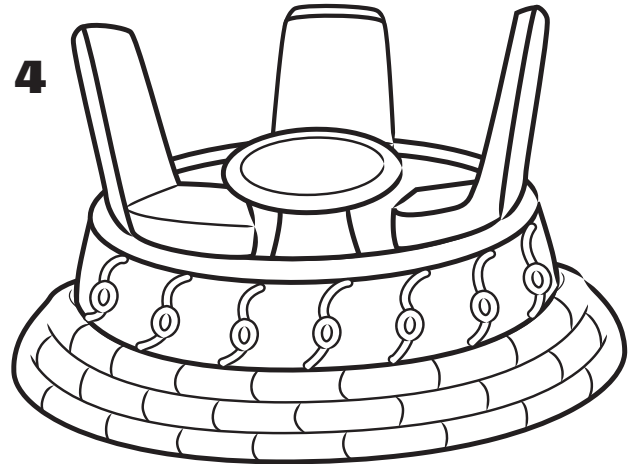
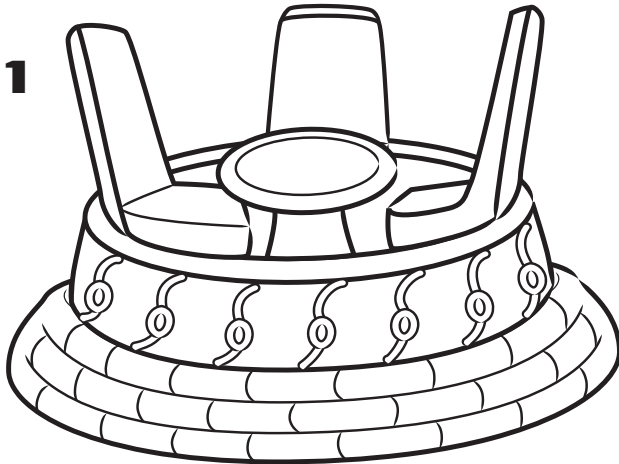

Answer: 3

# Crossword Puzzle

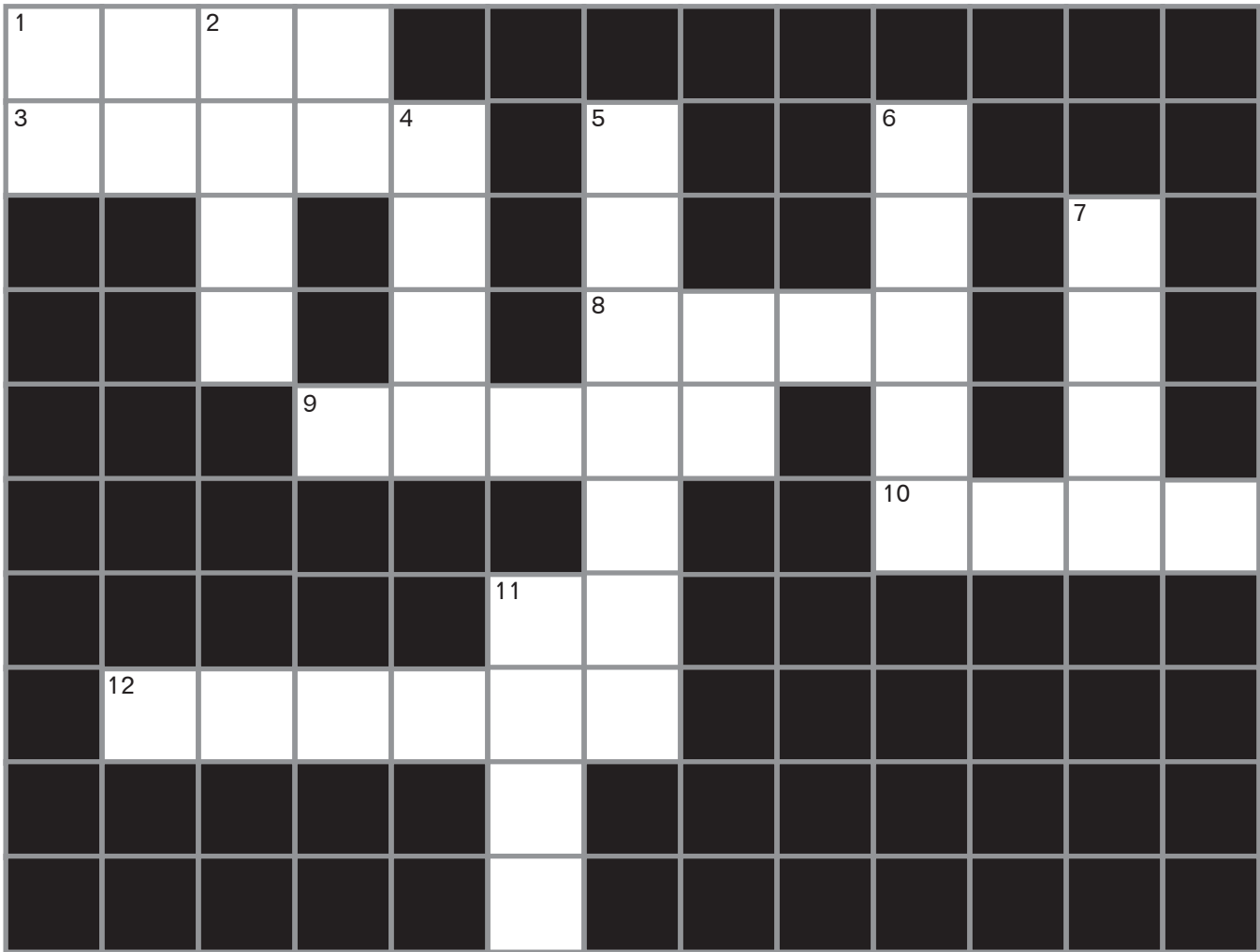

## Across

1. You walk on feet, while dogs walk on \_\_\_\_.
3. When going for a walk, your dog should be on a \_\_\_\_.
8. A dog may bark at a bird in a \_\_\_\_.
9. Dogs love to roll around on the green \_\_\_\_.
10. Another word for a story is a \_\_\_\_.
12. A pretty breed of dog with curly hair and long, floppy ears.

## Down

2. Poodles love to run but they also love to go on a \_\_\_\_.
4. \_\_\_\_ grows on your head as well as a poodle's head.
5. If your puppy is not inside she's probably \_\_\_\_.
6. Give your dog a \_\_\_\_ when he does a trick.
7. Use one of these to play fetch with your puppy.
11. Rather than work, puppies and kids would rather \_\_\_\_.

Across: 1) paws, 3) leash, 8) tree, 9) grass, 10) tale, 12) poodle  
Down: 2) walk, 4) hair, 5) outside, 6) treat, 7) ball, 11) play

# Word Search

Find and circle the words in the puzzle below.

BALLOONS  
BUMPER CAR  
CANDY  
CAROUSEL  
FERRIS WHEEL  
FUN

FOOD  
FRIENDS  
GAMES  
ICE CREAM  
RIDES  
ROLLER COASTER



B U M P E R C A R A S D J  
S Z C A R O U S E L D Q U  
N Q W E A F E C R M N D C  
O L N V B M V D P X E F A  
O K J H A C N O O Y I O N  
L J G G F T R B S O R U D  
L E E H W S I R R E F X Y  
A E D O O P K B S P D W Q  
B Z Y U M A E R C E C I A  
R E T S A O C R E L L O R



How many words can you make using the letters in

# AMUSEMENT PARK

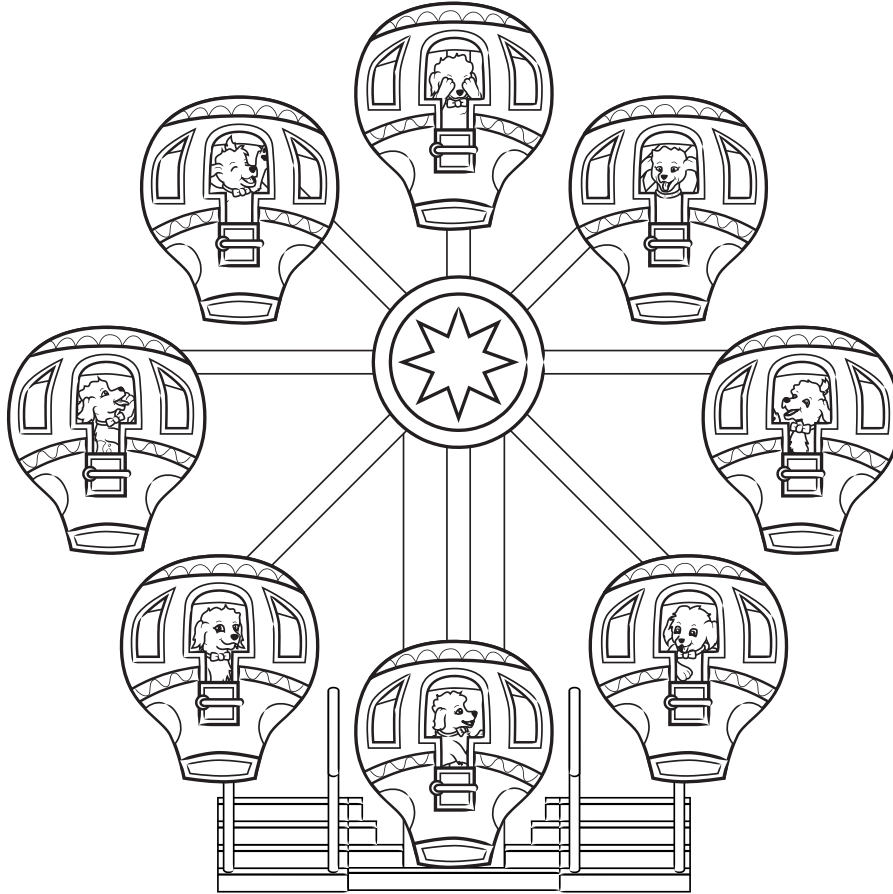

Example: RUN

_____	_____	_____
_____	_____	_____
_____	_____	_____
_____	_____	_____
_____	_____	_____
_____	_____	_____
_____	_____	_____
_____	_____	_____
_____	_____	_____
_____	_____	_____

(How many more can you think of? There are over 500 possibilities!)

mean, pants, ark, neat, sea, take, near, tense...

Some answers: use, ten, me, man, muse, sun, sap, rap, tap, ruse, pat, net, ram, see, team, meet, peek, prank, preen, us,

# Poodle Mix-Up

Unscramble the words below.



C V N T A A O I

---

N A R I T

---

O D O U O R T S

---

M U E M R S

---

Answer: Vacation, Train, Outdoors, Summer

# Connect the Dots

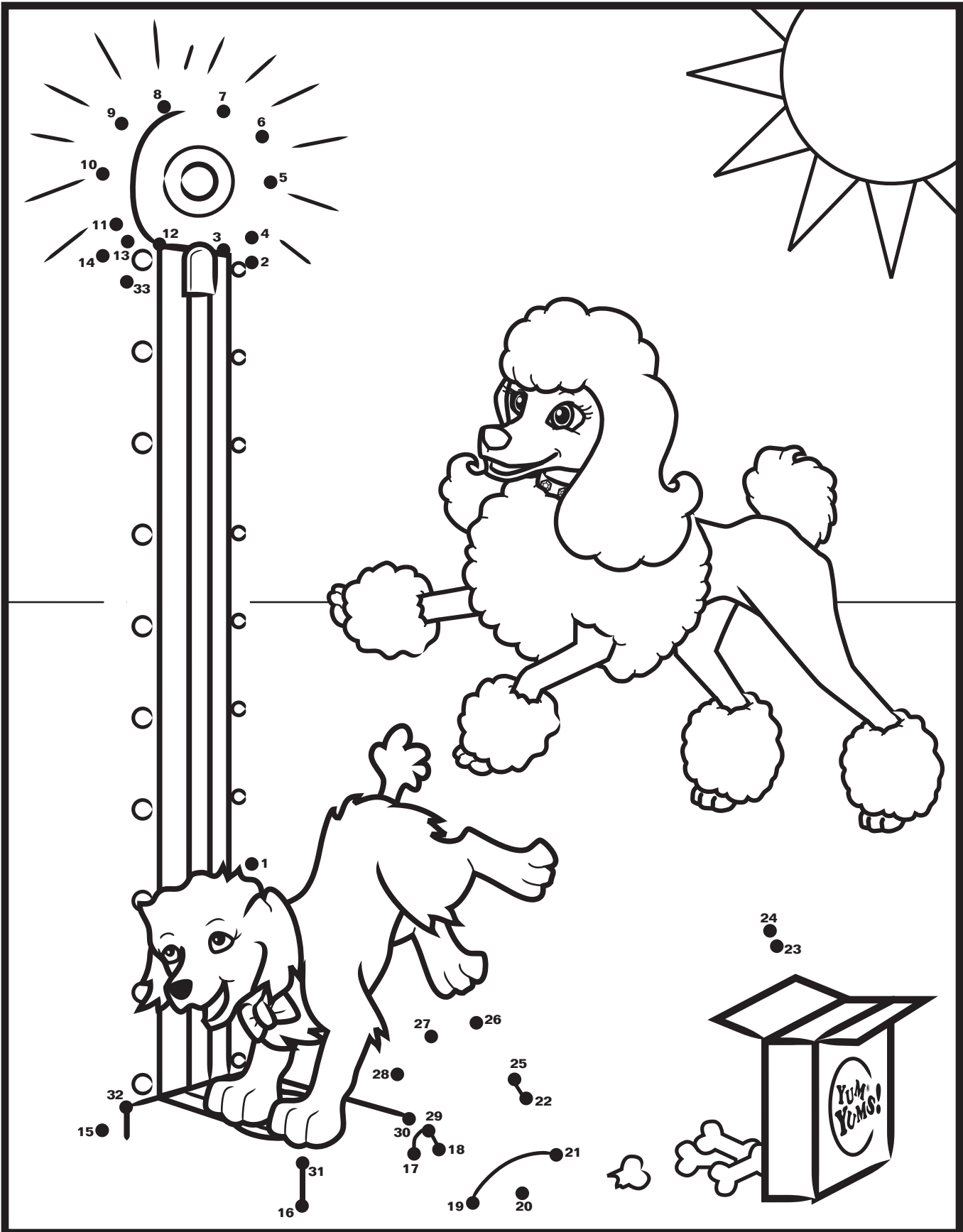

# Poodle Doodle

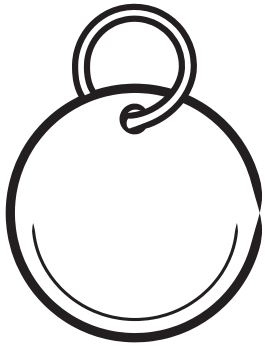

Use the grid to help you  
draw a poodle puppy.  
Be sure to give your puppy  
a name and print it on his or  
her tag when you are done!

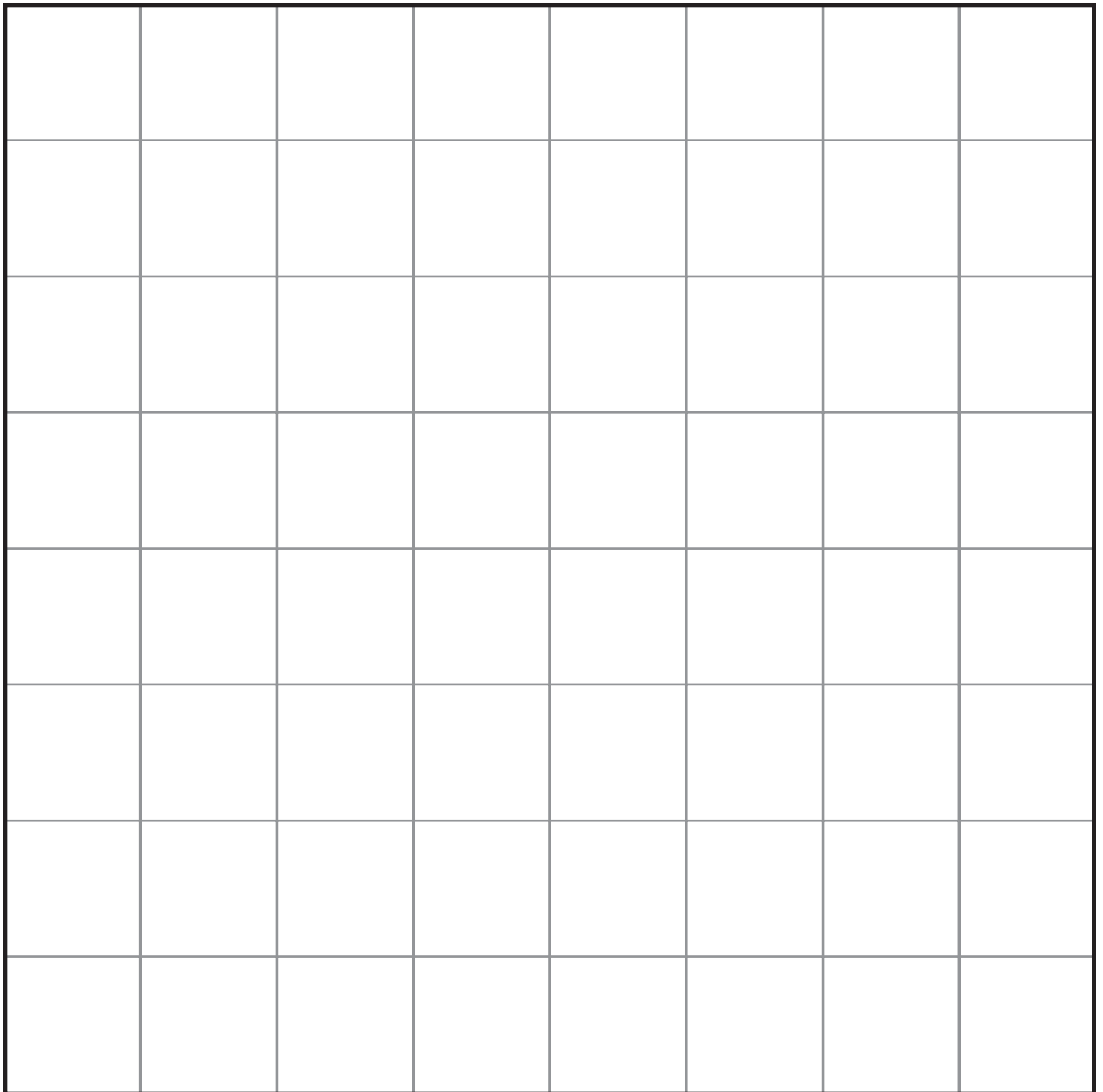
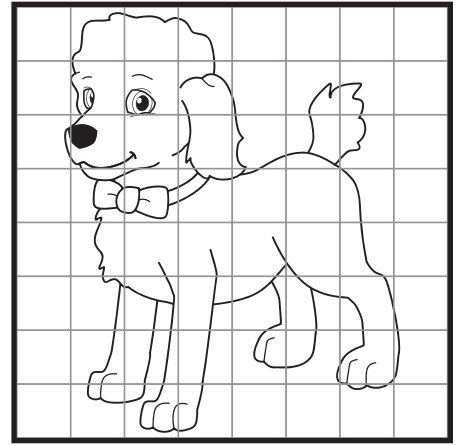

# Let's Draw!

Follow the steps to draw a rocket.

**Step 1**



**Step 2**

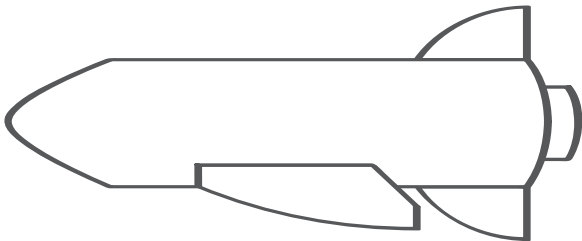

**Step 3**

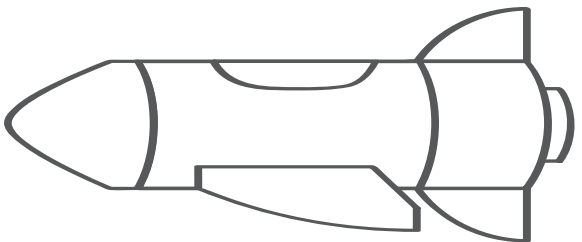

**Step 4**

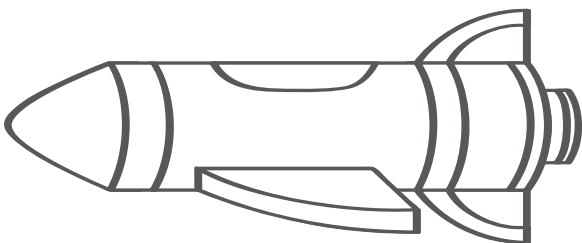



# Let's Draw!

Follow the steps to draw a bumper car.

**Step 1**

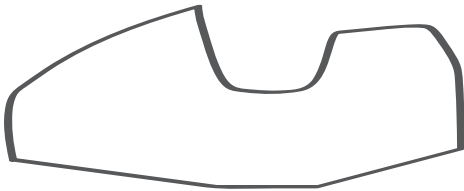

**Step 2**

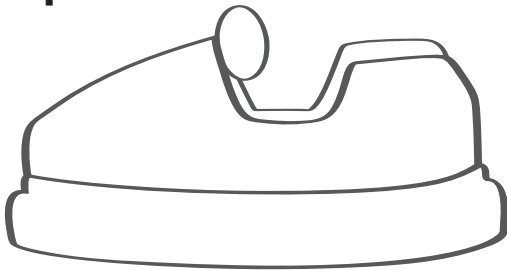

**Step 3**

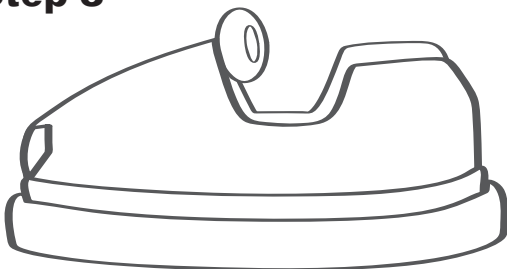

**Step 4**

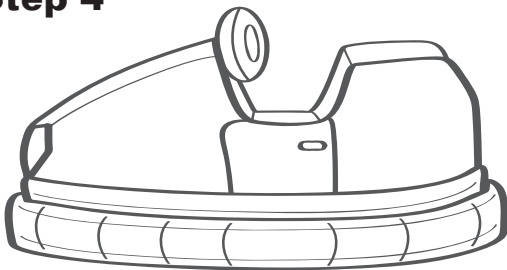

# Connect the Dots

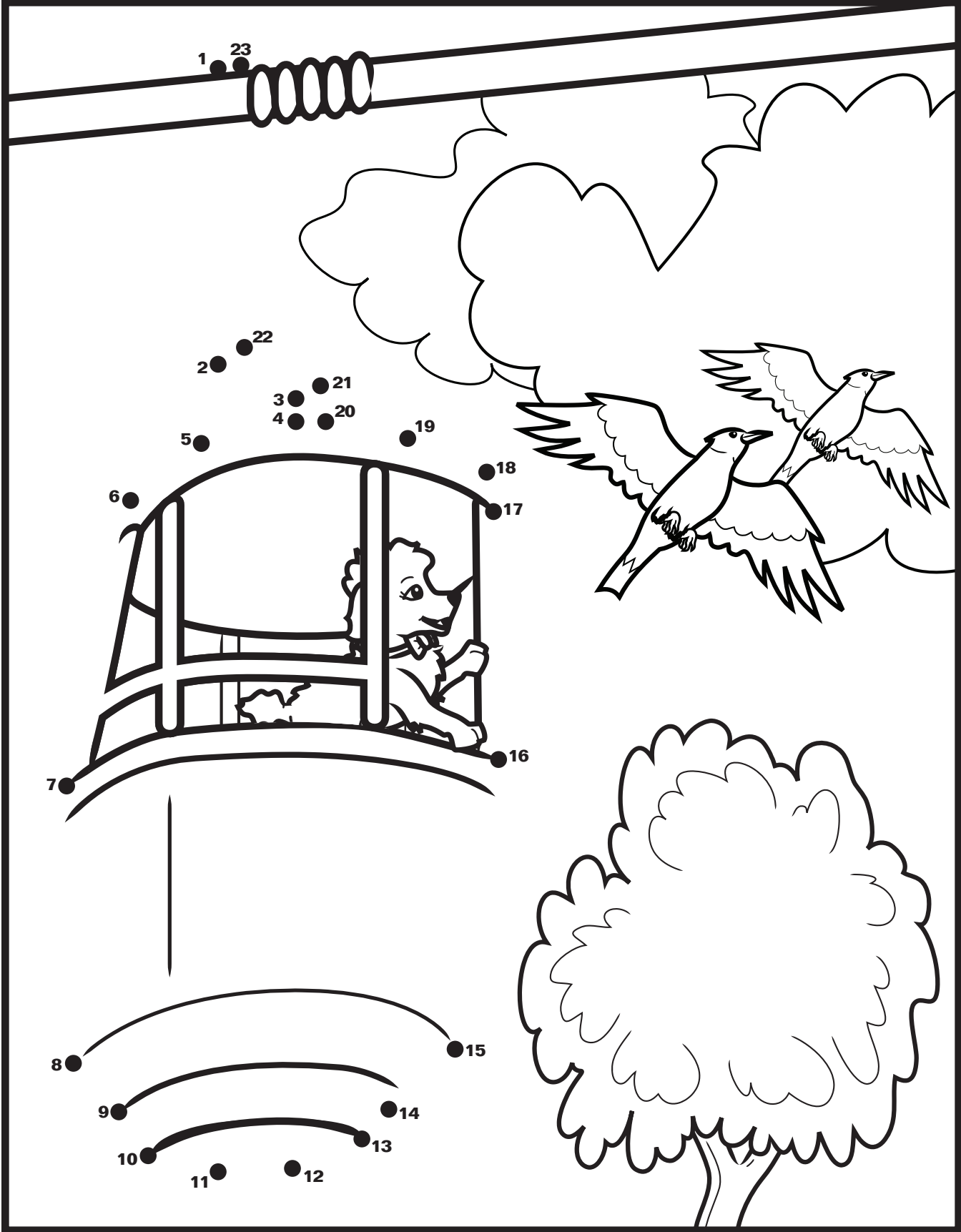





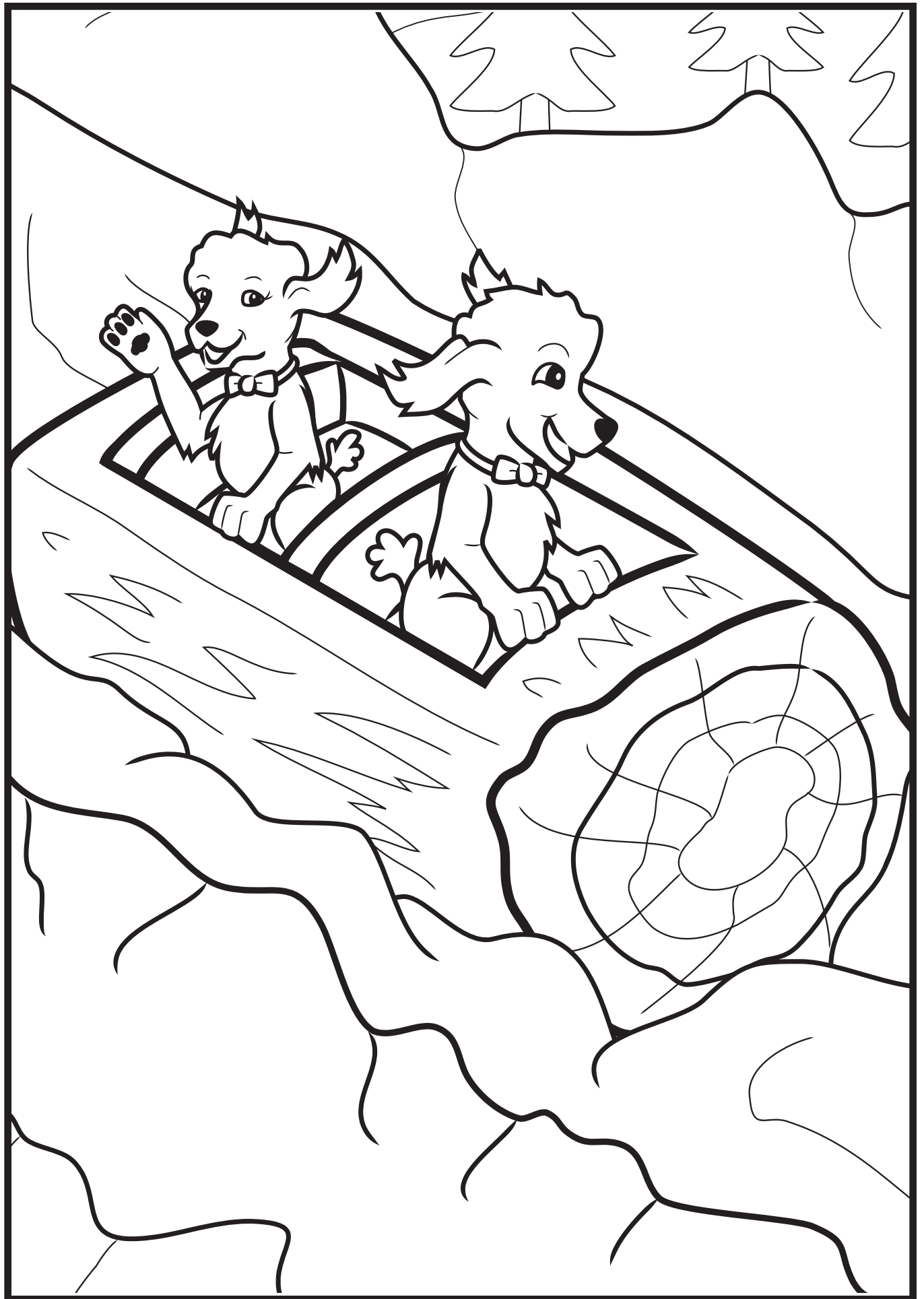







# Let's Do The Poodle Dance!

(page 1 of 4)

**1**

Hi, I'm Deja Vu, and I'm going to teach you the Poodle Dance!

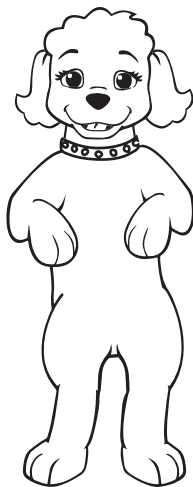

**2**

Wiggle left and right 9 times.

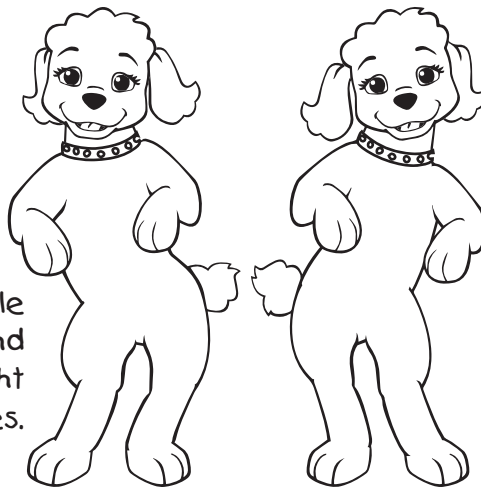

**3**

Open your arms wide and clap your paws 2 times.

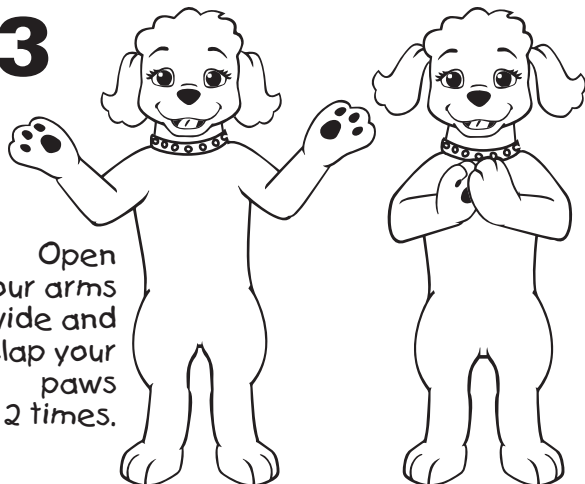

**4**

Step to the left 2 times.

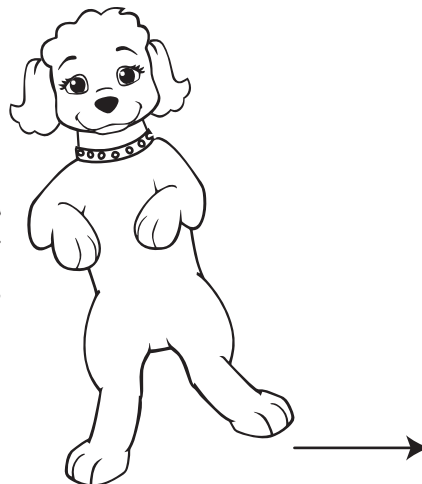

**5**

Now wiggle left and right 4 times.



**6**

And clap your paws together 6 times.

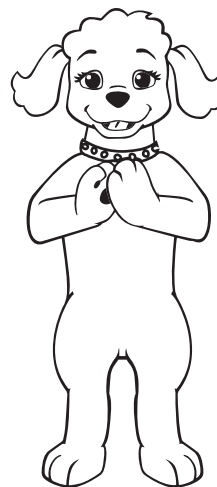

# Let's Do The Poodle Dance!

(page 2 of 4)

**7**

Spin all  
the way  
around.

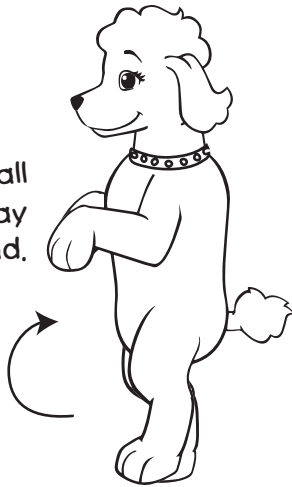

**8**

Jump up  
into the air  
and land  
on your  
feet.

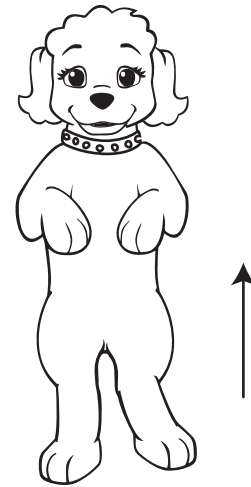

**9**

Now point  
to your eye  
and say, "I."



**10**

Make a  
heart shape  
with your  
arms above  
your head  
and say,  
"LOVE."

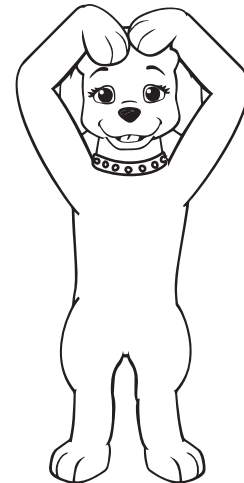

**11**

Shake your  
bottom,  
point to  
your tail  
and say,  
"THE  
POODLE  
TALES!"



**12**

Wag  
your tail  
6 times.



# Let's Do The Poodle Dance!

(page 3 of 4)

**13**

Jump up into the air while spinning to your left.



**14**

Land on your feet.

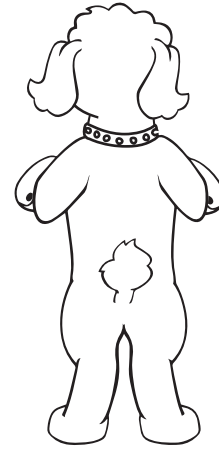

**15**

Wiggle right and left 6 times.

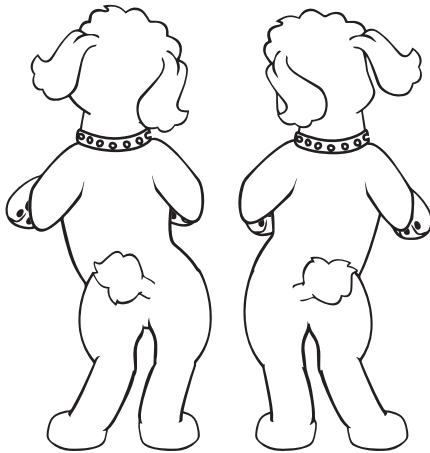

**16**

Clap your paws together 2 times.



**17**

Step to the left 2 times.

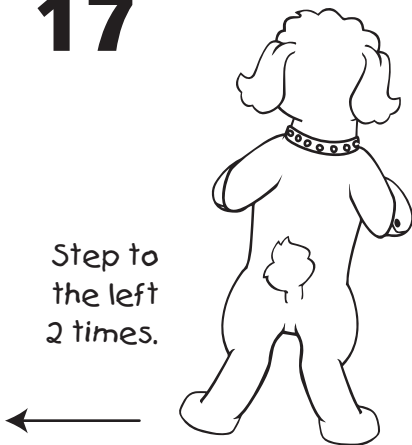

**18**

Wiggle right and left 4 times.

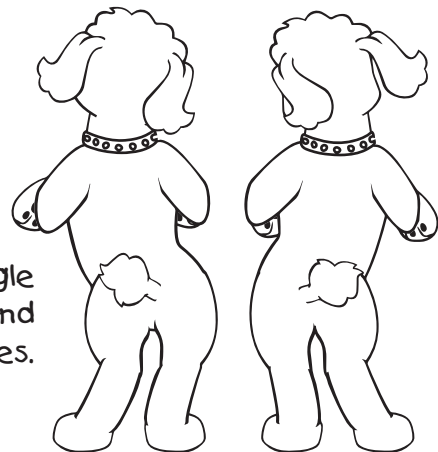

# Let's Do The Poodle Dance!

(page 4 of 4)

**19**

Clap your  
paws  
together  
2 times.



**20**

Wiggle  
right and  
left 4 times.

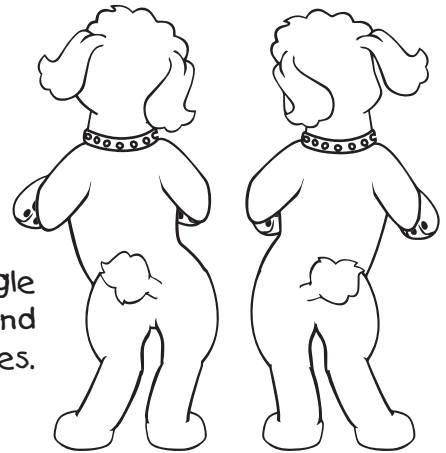

**21**

Now whirl  
around and  
say, "I."



**22**

"LOVE."

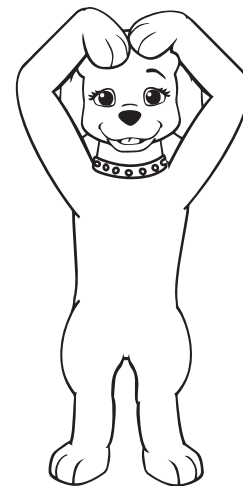

**23**

"THE  
POODLE  
TALES!"



**24**

Take a bow.  
You are  
awesome!



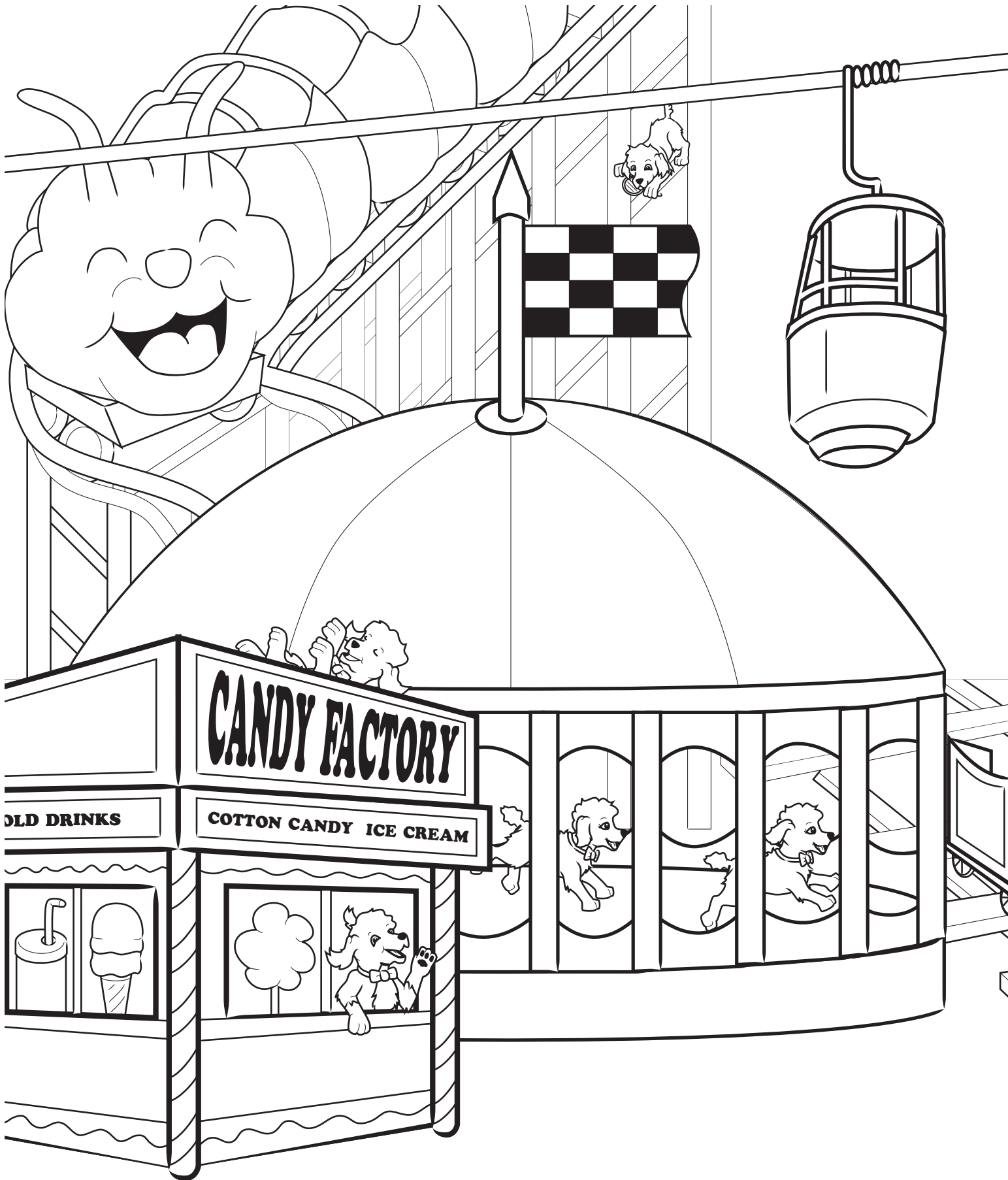

**Can you find**

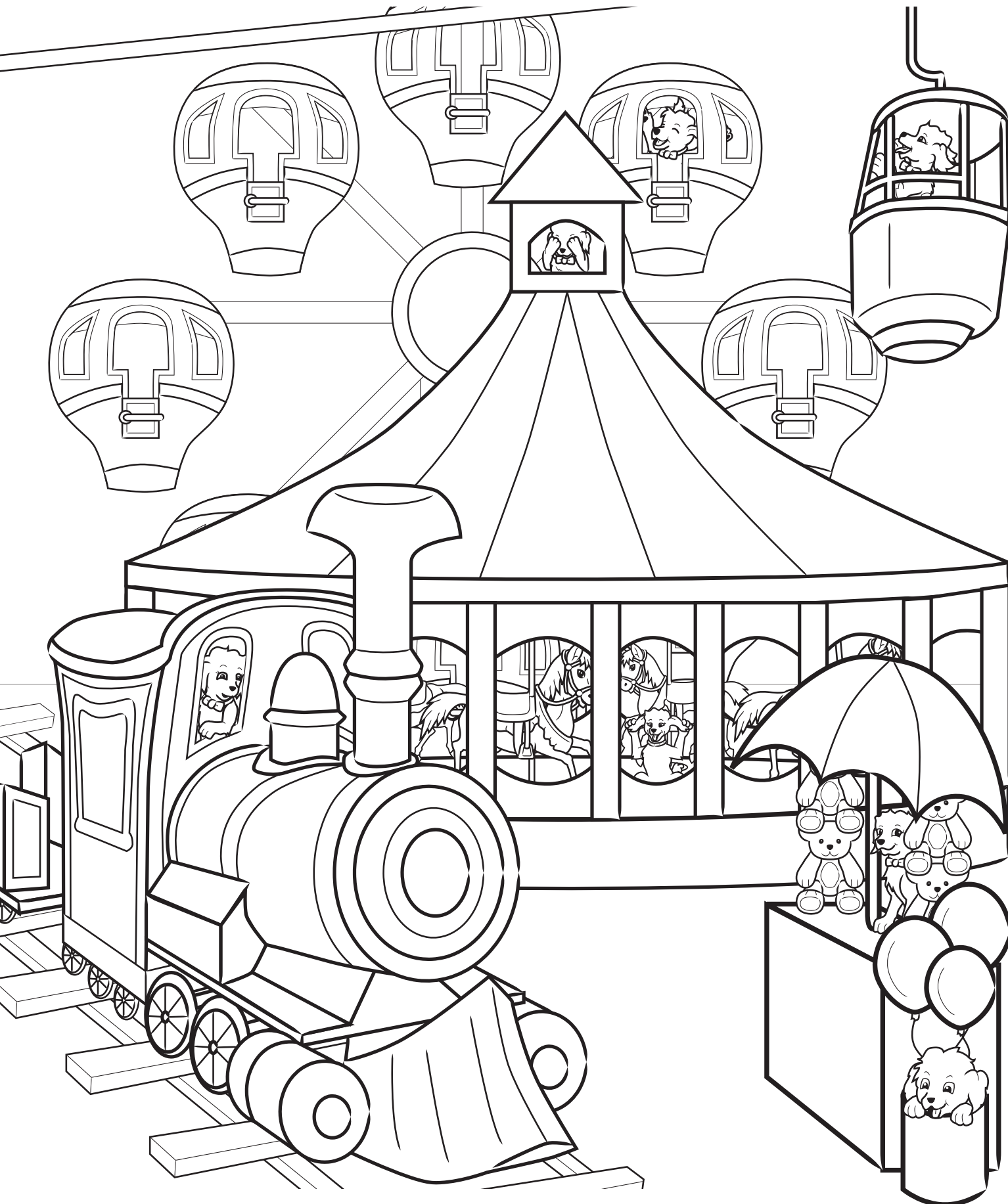

**all 12 puppies?**



# Lost In The Amusement Park

Help the puppy find his way back to his mommy.



**START**

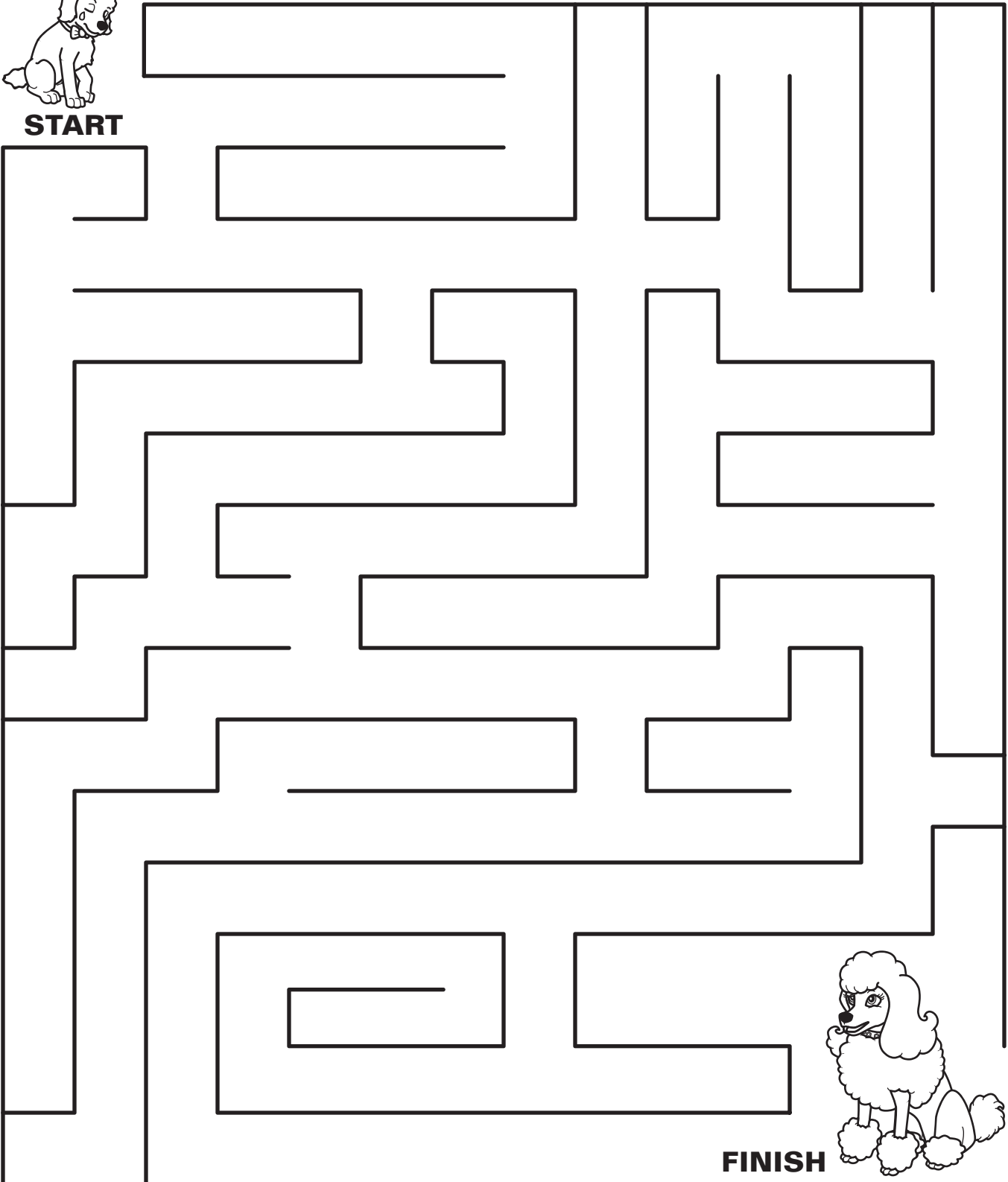

**FINISH**



© Toni Tuso Faber. All rights reserved.  
THE POODLE TALES is a trademark and service mark of Toni Tuso Faber.